

**GLASSFIRE**  
SERRAMENTI VETRATI TAGLIAFUOCO

**GlassFloor Horizontal REI60**

# SAFETY

Our range of products includes a glass floor covered by REI 60 fire rating no. LZP01-2326/16/Z00NZZP.

Fire resistance tests of the REI 60 type glass floor was carried out at the Fire Testing Laboratory of the Building Research Institute by a body accredited by the Polish Centre for Accreditation no. AB 023.



## EUROPEAN CLASSIFICATION

The glass design ensures fire integrity and protection against flames and fumes.



The glass design ensures fire integrity and protection against flames and fumes, as well as partial thermal insulation; max thermal radiation value is 15kW/m<sup>2</sup>.



The glass design ensures fire integrity and protection against flames, fumes and increased thermal insulation; a temperature increase was limited to 140 K; max temperature increase – 180 in a given point.



**R** LOAD COEFFICIENT

## FIRE RATED GLASS OPERATING PRINCIPLE



First, fire causes cracking to the external glass unit at stress spots.



The layer of nanogel expands forming a protective insulating layer.



The formed protective layer stops an increase of the glass surface temperature.



## PANEL SECTION

The panel is designed as a steel-glass floor component ready to be arranged on a sub-structure.

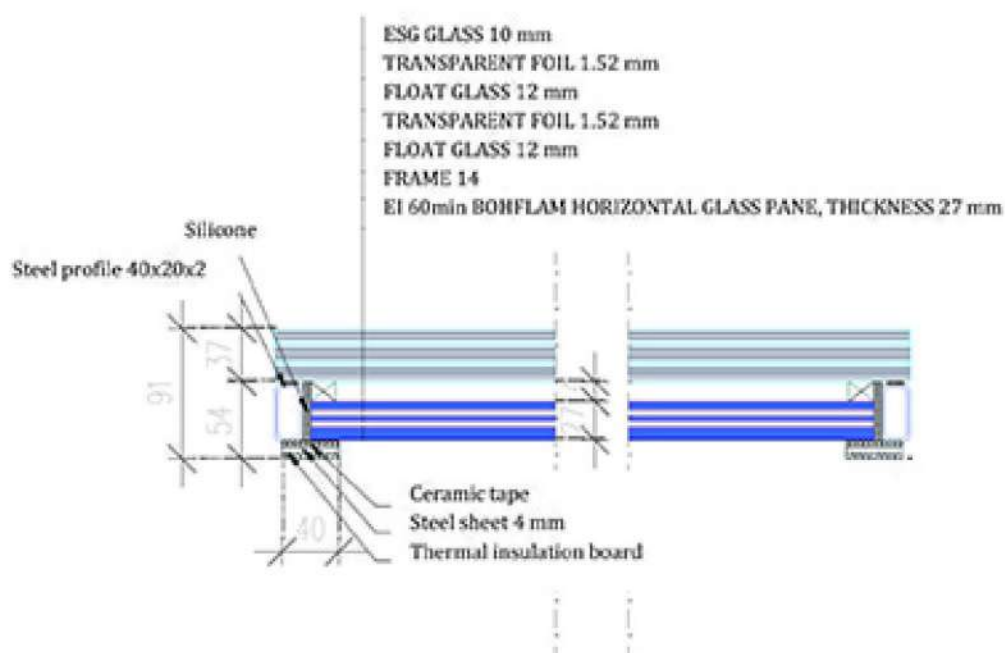

## EXAMPLES OF SHAPES

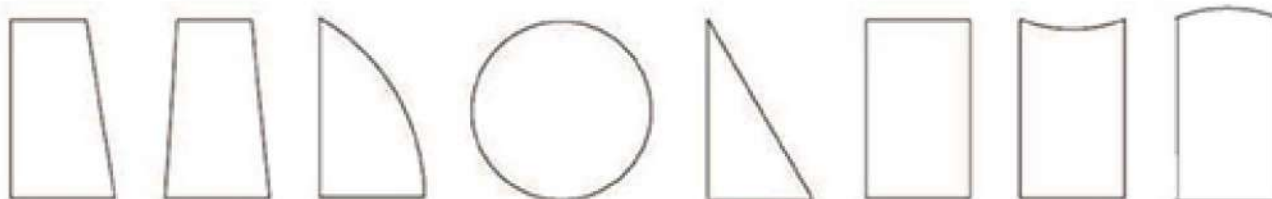

## PANEL TOP VIEW

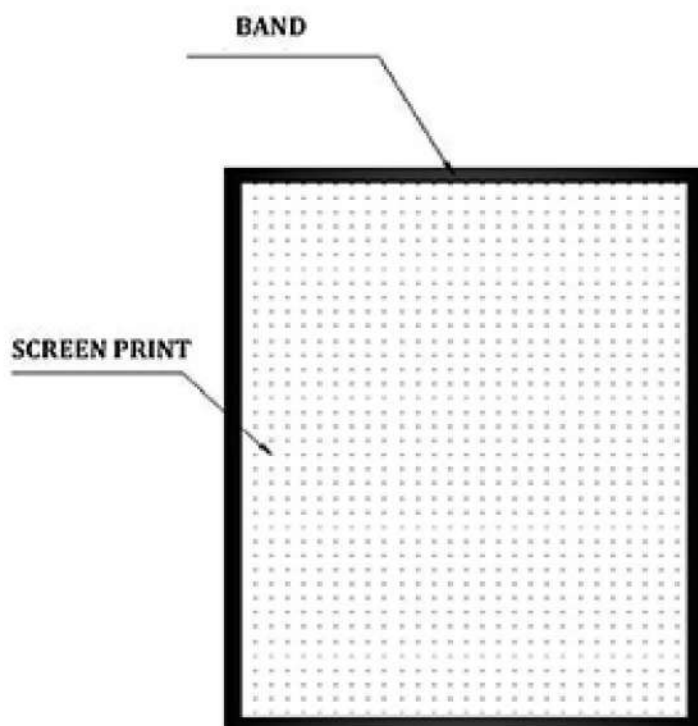

### SCREEN PRINTS

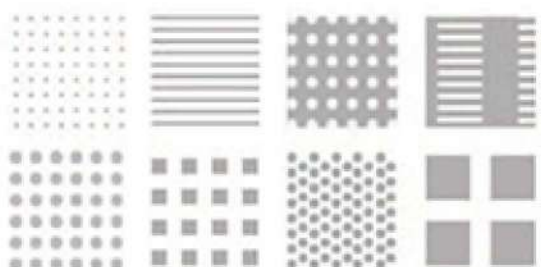

### TABLE OF COLOURS - BANDS

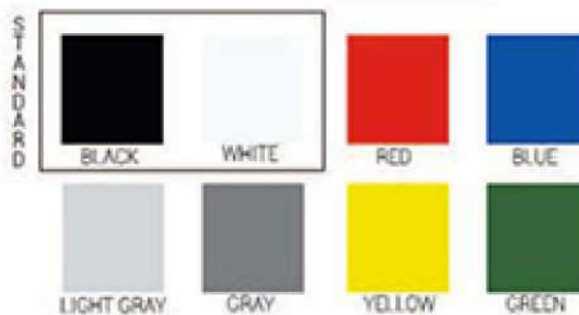

Anti-slip screen print, class R10 as per DIN 51130

TD P 40 pattern

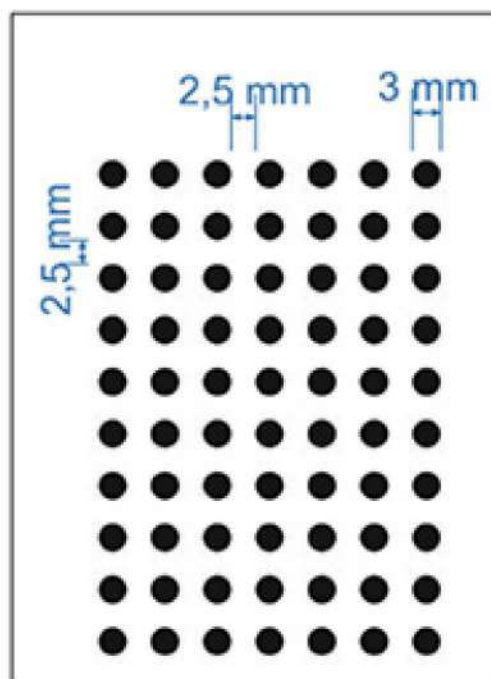

TD Q 68 pattern

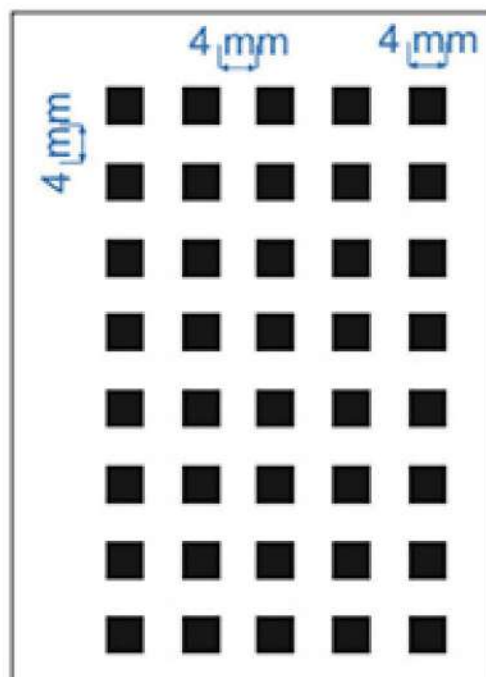

Digital ceramic print up to 720 dpi

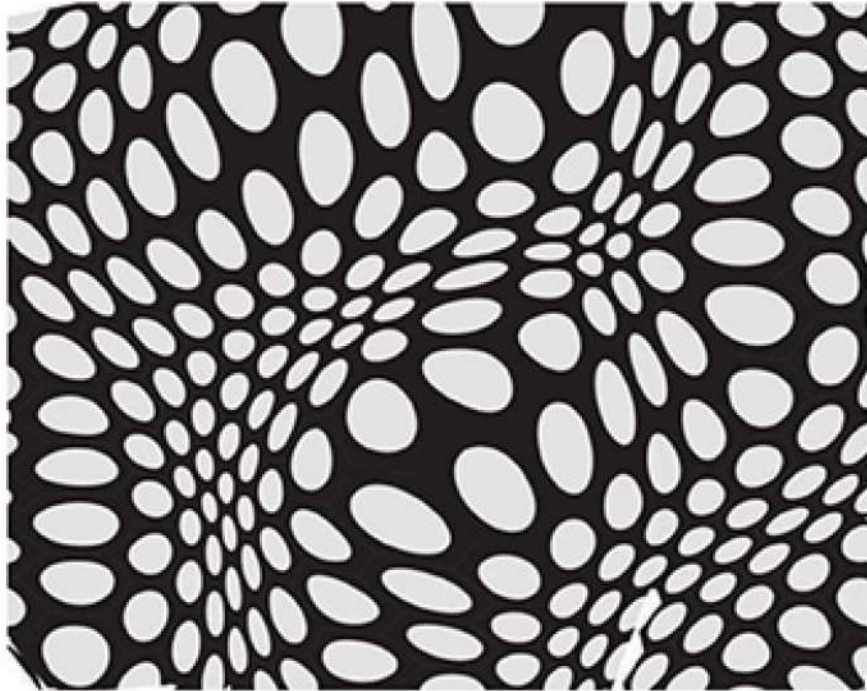



## EXAMPLES OF ASSEMBLY METHODS

### ➤ REI 60 SINGLE CHAMBER GLASS FLOOR BASED ON A STEEL GRATE

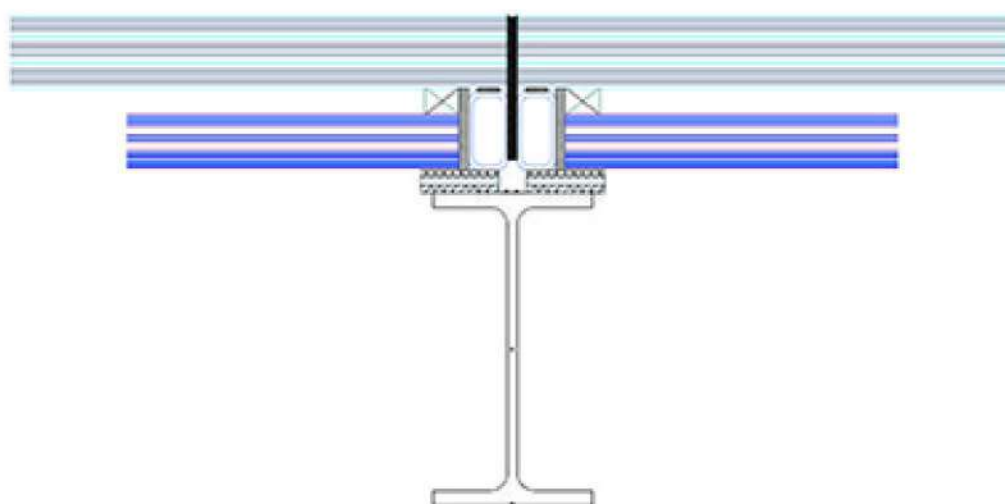

### ➤ REI 60 SINGLE CHAMBER GLASS FLOOR BASED ON CONCRETE

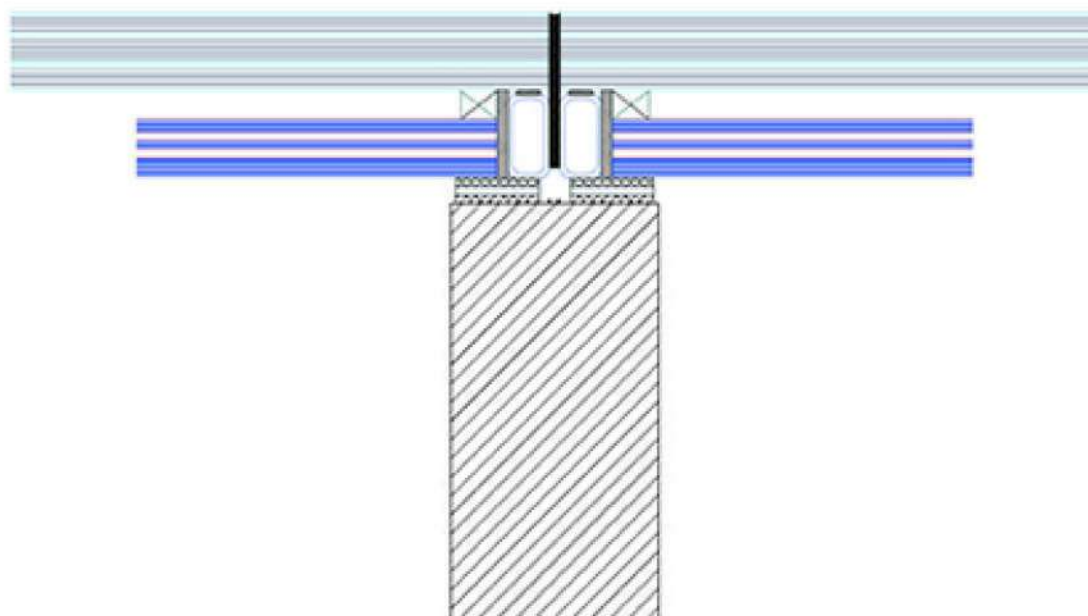

➤ **E60 DOUBLE CHAMBER GLASS FLOOR**

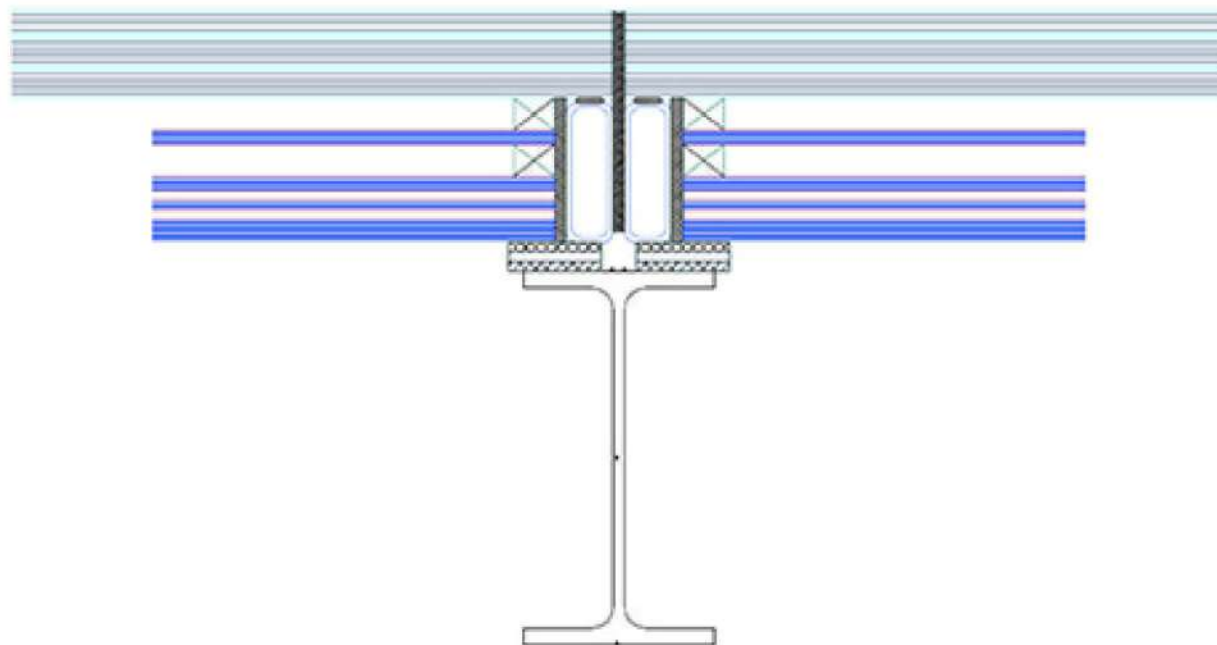

➤ **REI 60 DOUBLE CHAMBER GLASS FLOOR - HEATING FLOOR**

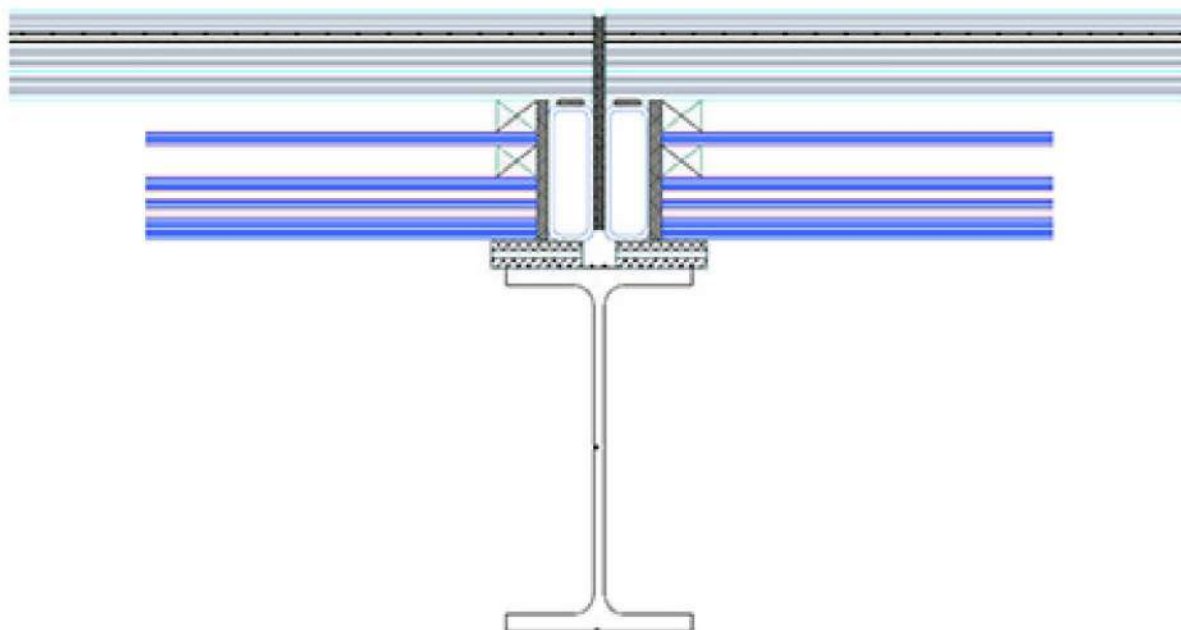

Heated glass panes can be used to melt snow and ice and prevent condensation of water on glass panes.

Heated glass controller:

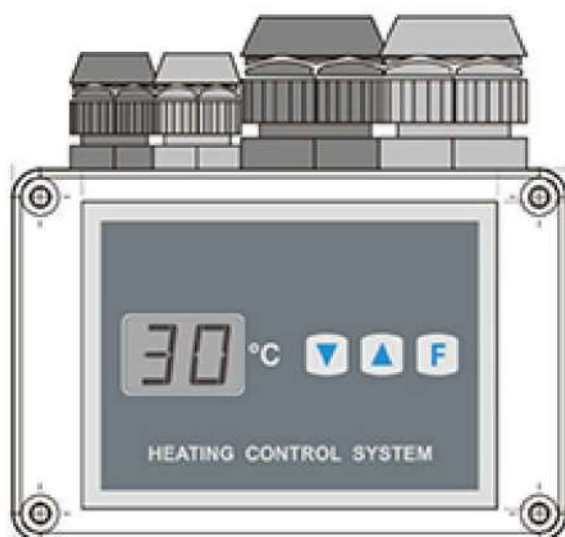

Connection diagram:

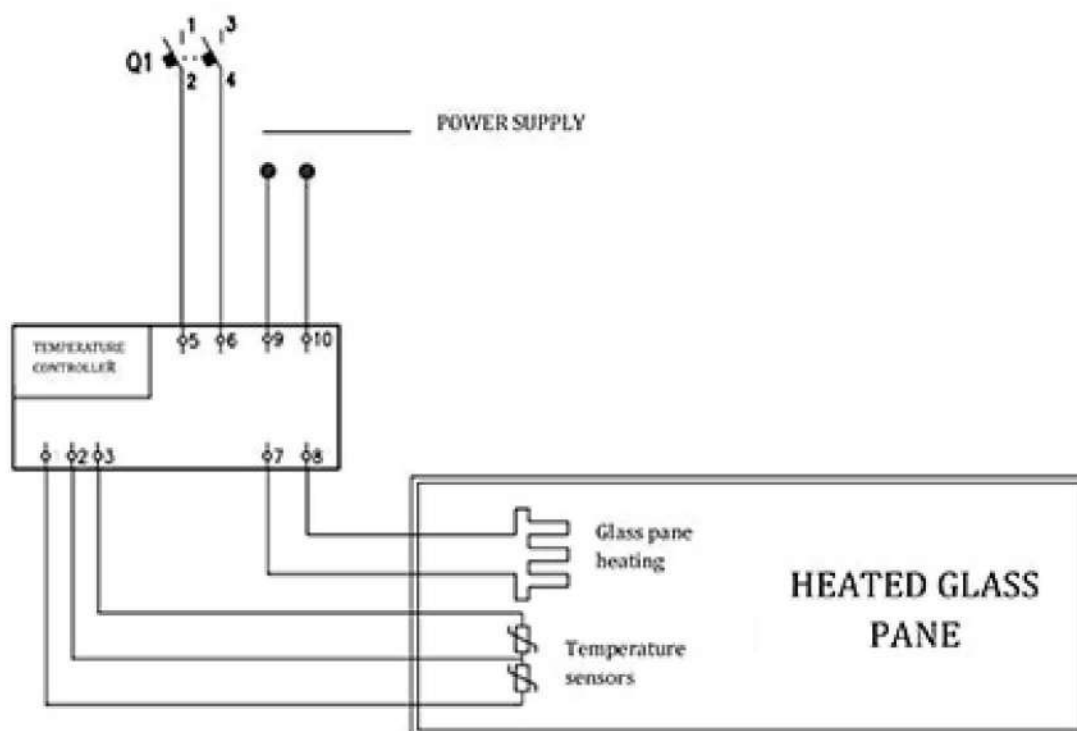

## REI 60 FLOOR TECHNICAL SHEET

Technical requirements for a sub-structure according to the classification of glass floors.

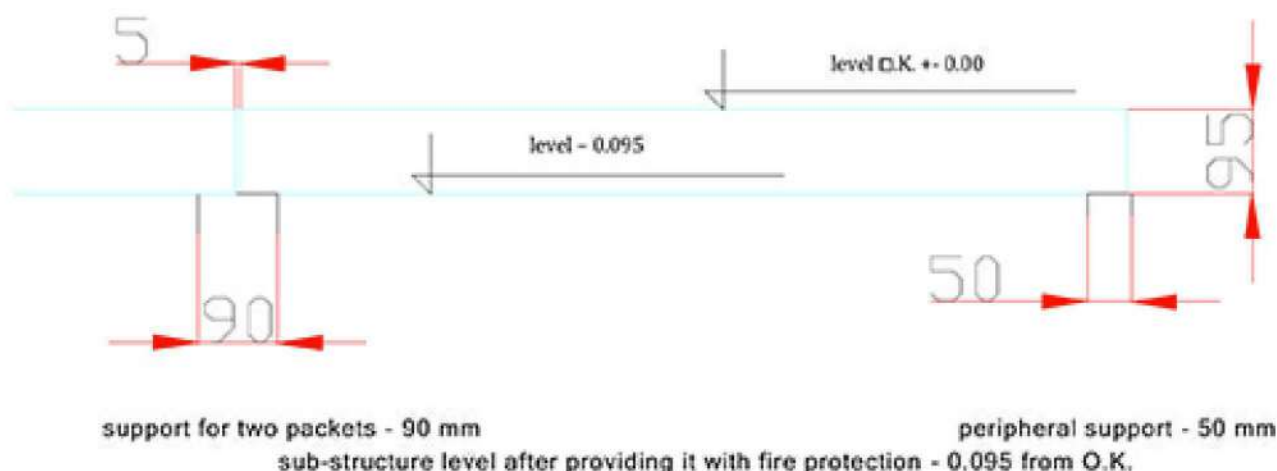

1. The supportive structure of glass panels designed as a steel grate made of rolled profiles of grate component connection – welded.
2. Max design bending of the grate under normal conditions is  $f_k \leq L/268$ .
3. Bending stress of beams under normal conditions is  $\alpha_M < 49\%$ .
4. Fire protection of the grate steel structure is provided in class R60 for critical temperature of steel  $\theta_{kr} = 350 \text{ }^\circ\text{C}$ .
5. Max characteristic service load of the floor under normal conditions is  $q_k \leq 5.00 \text{ kN/m}^2$
6. Max panel dimensions: 2300 x 1200 mm.
7. Max dimensions of the panel with steps: 2700 x 1600 mm (size of top glass panes).

## REFERENCE STANDARDS

1. PN-EN 1365-2:2014-12. *Fire resistance tests of load-bearing components. Part 2: Ceilings and roofs.*
2. PN-EN 13501-2: 2016-07. *Fire classification of construction products and building elements. Part 2: Classification using data from fire resistance tests, excluding ventilation systems.*
3. PN-EN 1993-1-2: 2005. *Design of steel structures. Parts 1-2: General rules – Structural fire design.*
4. *Report no. LZP01-2326/16/Z00NZZP on fire resistance tests.*

## OUR PROJECTS

### ➤ FIRE TESTING - 2018



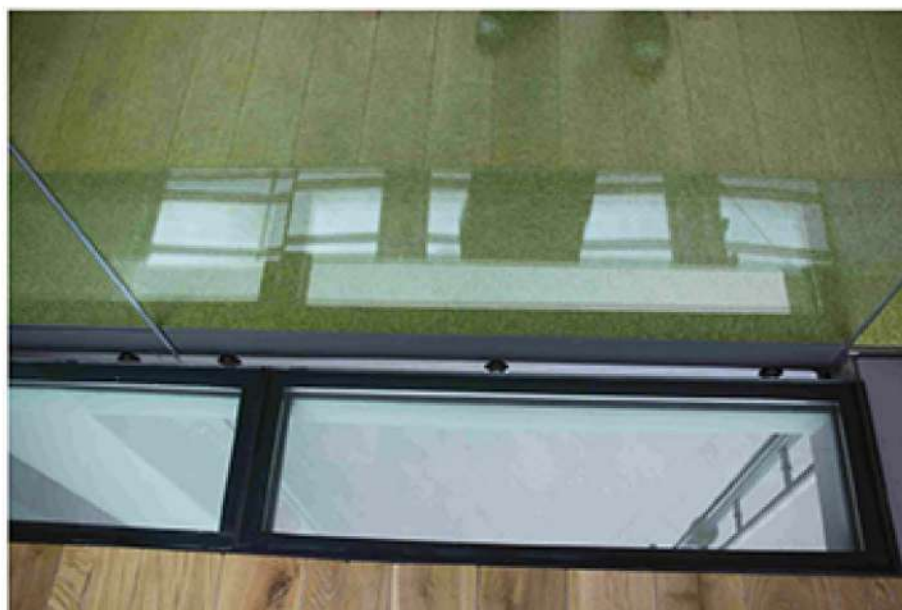

V







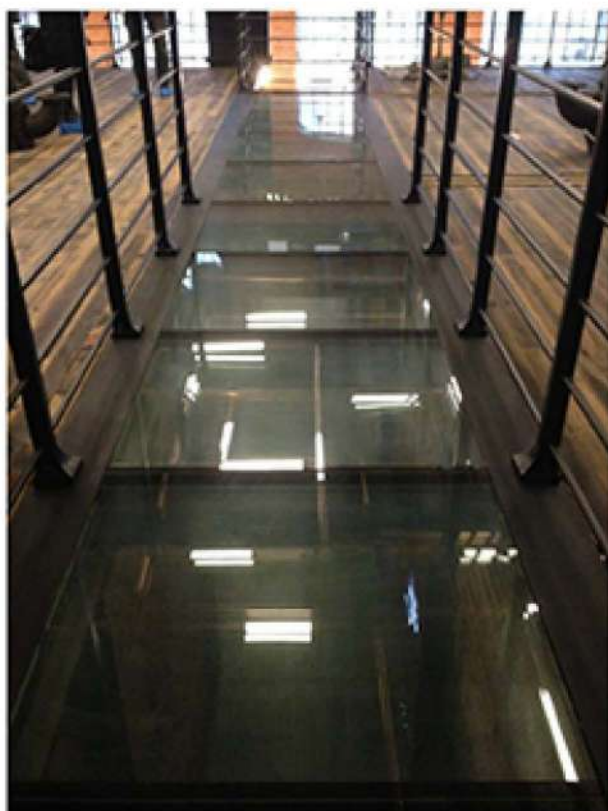



**GLASSFIRE - Via Labriola, snc - (Zona Industriale)  
73019 Trepuzzi • LECCE • Italy  
Telefono: +39 0832 757979 • Fax: +39 0832 760241  
E-mail: [info@glassfire.it](mailto:info@glassfire.it) • PEC: [glassfiresrl@legalmail.it](mailto:glassfiresrl@legalmail.it)**